

NEW

App

Sistema appendi attrezzi
Tool-hanging system

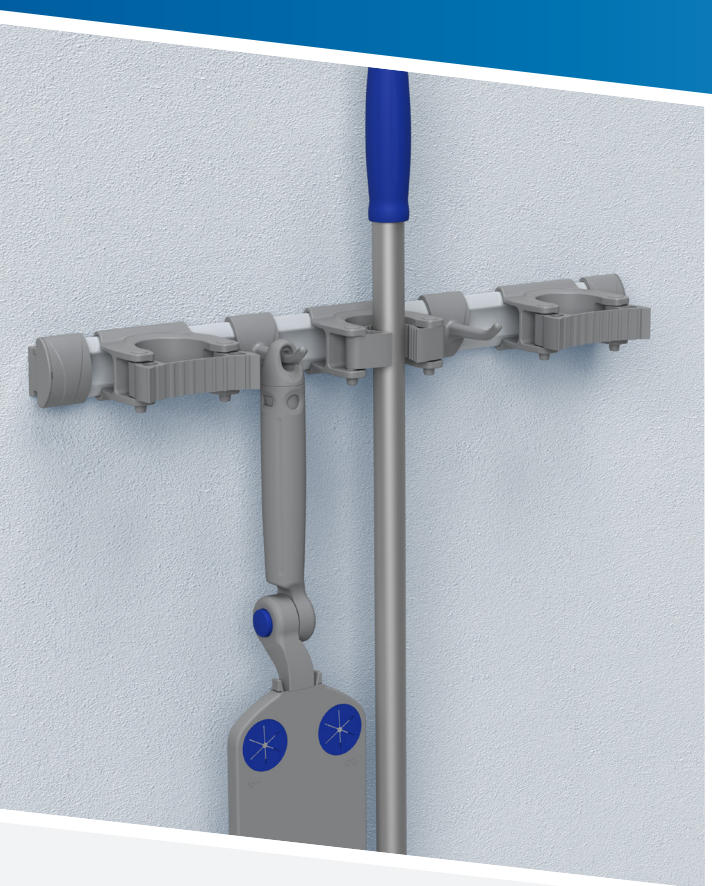

Ogni attrezzo
al suo posto
*Each tool
in place*

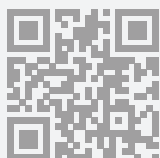
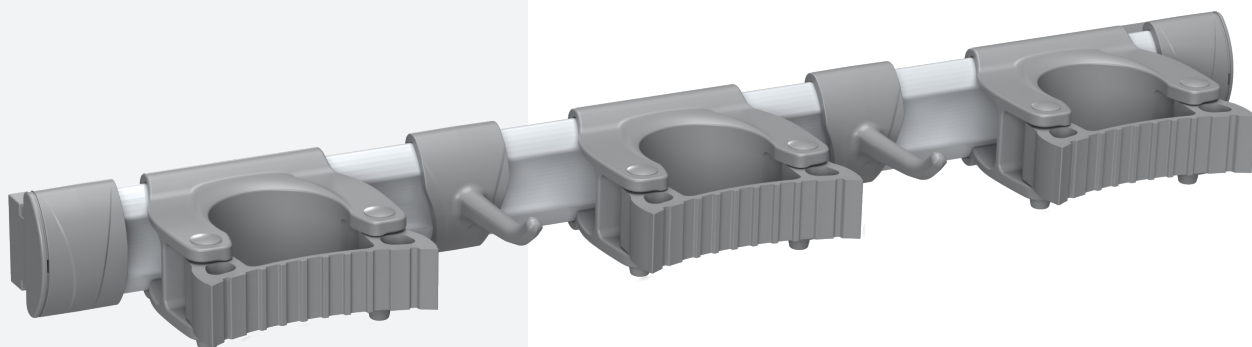

FILMOP[®]
INTERNATIONAL

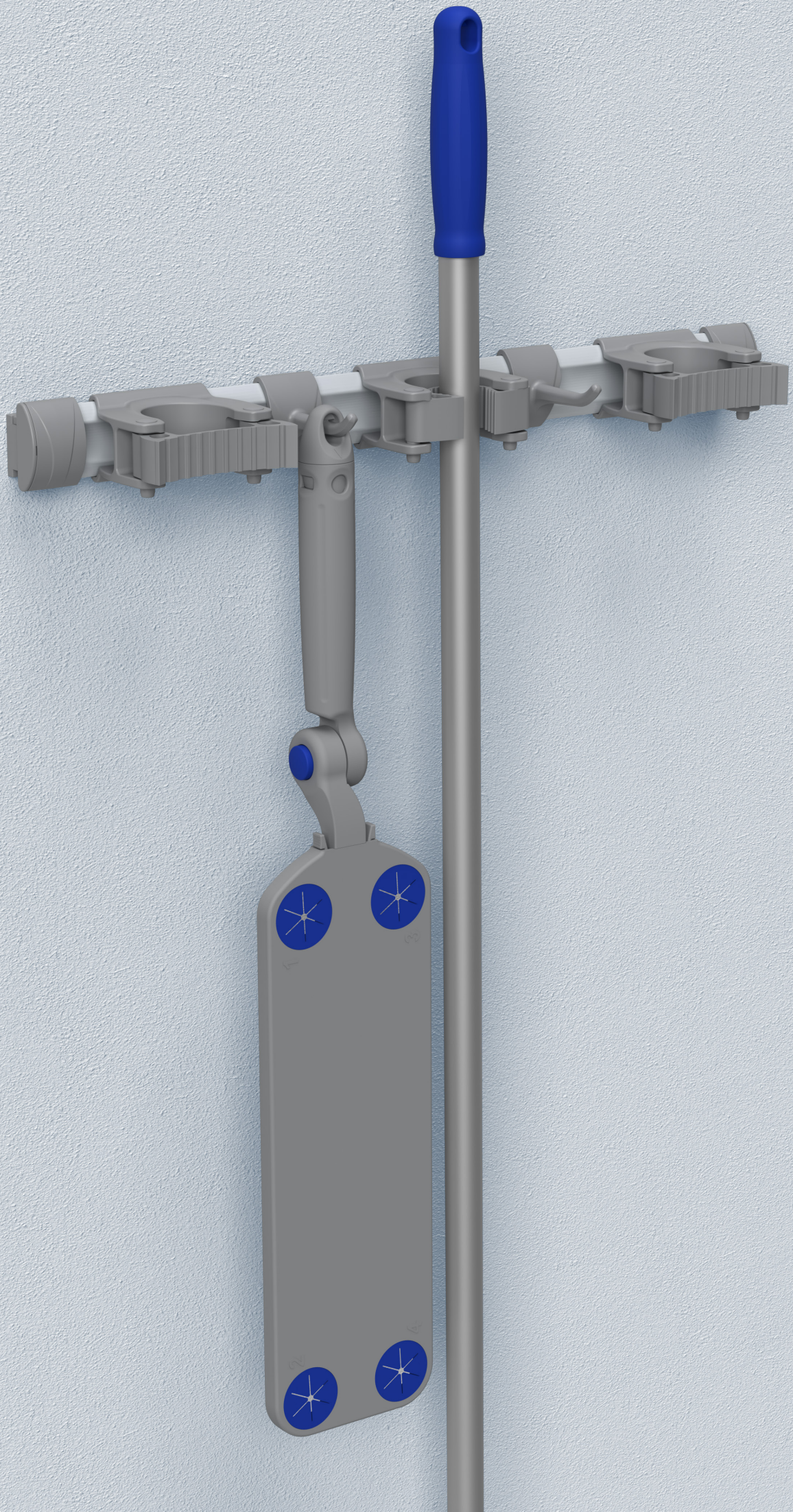

ORGANIZZA AL MEGLIO GLI ATTREZZI

BETTER ORGANISE YOUR TOOLS

L'esclusivo **sistema appendi attrezzi App** permette di destinare **un posto a ogni attrezzo**: l'operatore può così riporre comodamente le attrezzature a operazioni ultimate, beneficiando di una **postazione ordinata**.

Disponibile in **due dimensioni** e dotato di **ganci e supporti per manici con diametro da 20 a 30 mm**, rappresenta uno strumento indispensabile per appendere e organizzare gli attrezzi in maniera efficiente.

Ganci e portamanici sono disponibili anche nella **versione progettata per il fissaggio a muro**, particolarmente indicata per creare **postazioni estremamente compatte**.

*The unique **App tool-hanging system** provides a **place for each tool**: the operator can conveniently hang up the equipment once operations are complete, benefiting from a **tidy location**.*

*Available in **two sizes** and equipped with **hooks and holders for 20 to 30 mm diameter handles**, it is an indispensable tool for efficiently hanging up and organising tools.*

*Hooks and handle holders are also available in a **version designed for wall mounting**, particularly suitable for creating **extremely compact workstations**.*



CONTROLLO IMMEDIATO

IMMEDIATE CHECK

Aumenta la visibilità degli attrezzi una volta riposti

Enhances visual display of tools when stored



ASCIUGATURA OTTIMALE

OPTIMAL DRYING

Consente un'asciugatura completa dopo la pulizia

Allows thorough drying after cleaning



LUNGA DURATA

LONG-LASTING

Evita deformazioni allungando la vita dei prodotti

Avoids deformations by extending product life



IGIENE ASSICURATA

ASSURED HYGIENE

Componenti facili da pulire grazie alla superficie liscia

Easy-to-clean components due to smooth surface



Caratteristiche - Features

PROGETTATO PER SODDISFARE OGNI ESIGENZA

DESIGNED TO MEET EVERY NEED

Le **barre da 30 e 50 cm** possono essere **liberamente combinate** tra loro e arricchite da **ganci e portamanici** così da comporre **ampie pareti attrezzate** secondo le specifiche esigenze.

La **versione da 30 cm** è inoltre ideale quando c'è poco spazio a disposizione, permette infatti di organizzare efficientemente anche le **postazioni ristrette**.

*The 30 cm and 50 cm bars can be **freely combined** and enriched with **hooks and handle holders** in order to compose **large wall units** according to specific needs.*

*The 30 cm version is also ideal when space is at a premium, as it can be used to efficiently organise even **small workplaces**.*

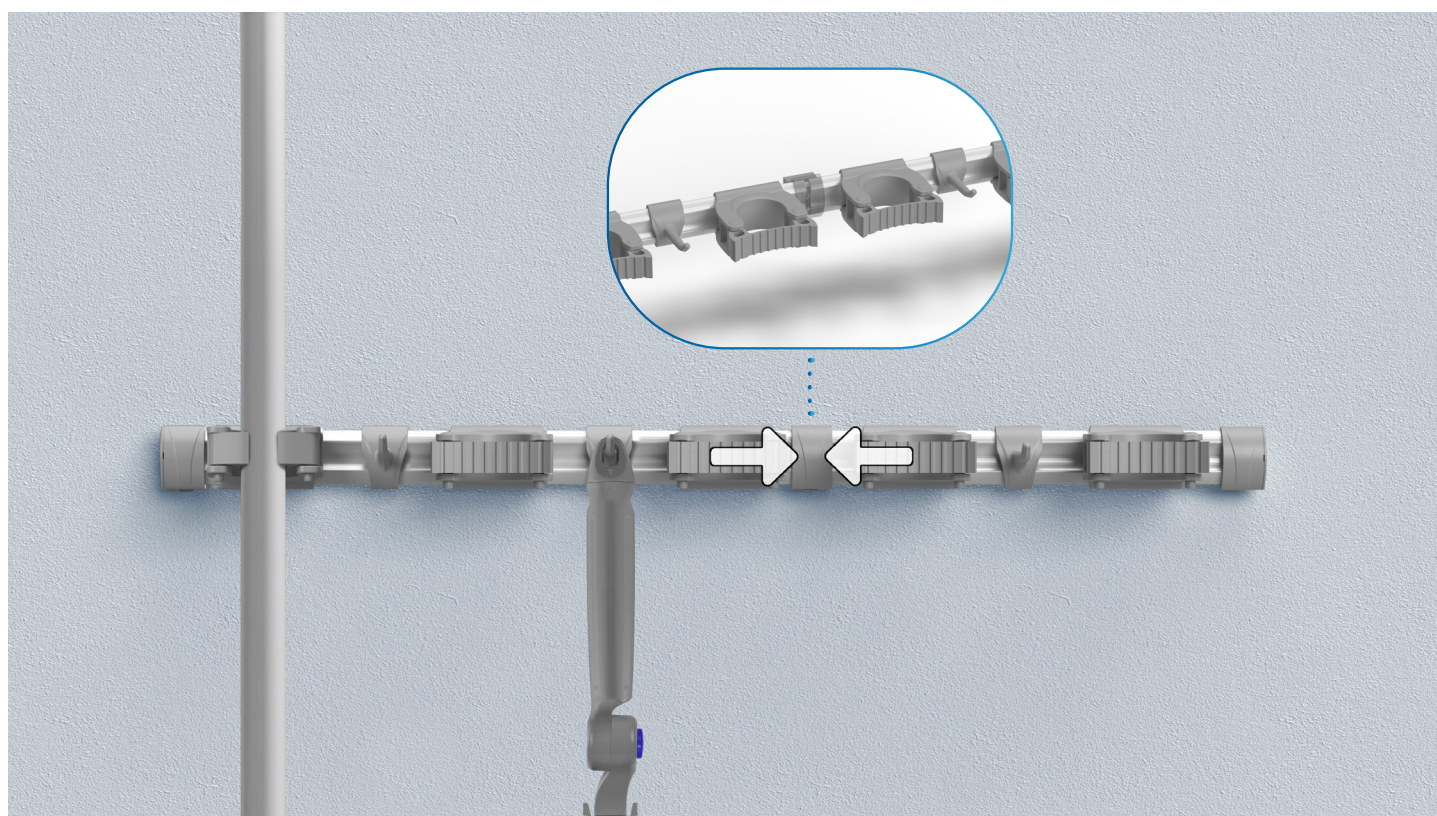

Infine, le **versioni a muro dei ganci e portamanici** consentono di **posizionarli ovunque** sfruttando al meglio lo spazio disponibile, anche quando è ridotto.

*Finally, the **wall-mounted versions of the hooks and handle holders** allow them to be **placed anywhere**, making the most of available space, even when it is small.*



Caratteristiche - Features

RISPETTOSO DELL'AMBIENTE

ENVIRONMENTALLY FRIENDLY

App assicura la massima sostenibilità nell'intero ciclo di vita, dalla produzione allo smaltimento: è infatti progettato per **durare a lungo** nel tempo e realizzato con **materiali completamente riciclabili**.

App ensures maximum sustainability in its entire life cycle, from production to disposal: it is designed to be **long-lasting** and made of **fully recyclable materials**.



Informazioni tecniche - Technical info

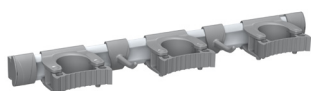

Barra appendi-attrezzi 50 cm
con 2 ganci e 3 attacchi
*Tools wall bar 50 cm with 2 hooks
and 3 handle holders*

COD. / REF.

0000SM00410



Gancio per barra appendi-attrezzi
Hook for Aluminium tools wall bar

COD. / REF.

P190212U

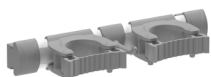

Barra appendi-attrezzi 30 cm
con 1 gancio e 2 attacchi
*Tools wall bar 30 cm with 1 hook
and 2 handle holder*

COD. / REF.

0000SM00409



Supporto a muro con 2 ganci
Wall support with 2 hooks

COD. / REF.

P190214U



Barra appendi-attrezzi 30 cm
Aluminium tools wall bar 30 cm

COD. / REF.

A1230203

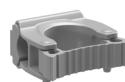

Supporto a muro con attacco 20/30 mm
Wall support with holder Ø 20/30 mm

COD. / REF.

P190215U



Barra appendi-attrezzi 50 cm
Aluminium tools wall bar 50 cm

COD. / REF.

A1230204

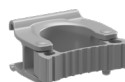

Attacco appendi-attrezzi 20/30 mm
Wall support with holder Ø 20/30 mm

COD. / REF.

P190213U



FILMOP INTERNATIONAL SRL (Soc. a Socio Unico)
Via dell'Artigianato 10/11, 35010 VILLA DEL CONTE (PD), ITALY
Tel. +39 049 9325066 - Fax +39 049 9325317
e-mail: filmop@filmop.com - www.filmop.com

Foto e contenuti potrebbero aver subito alcuni aggiornamenti
Photos and contents may have been updated

Distributore_Distributor



Certificazione di prodotto valida per una gamma di prodotti in plastica
Product certification valid for a range of plastic products



Certificazione di prodotto valida per una gamma di prodotti tessili
Product certification valid for a range of textile products



Certificazione di prodotto valida per alcuni mobili carrellati
Product certification valid for a selection of wheeled cabinets